

# HYDROPROTECTOR CLASS 1 BYPASS SEPARATOR DEVICE SPECIFICATIONS

- Underground installation, no loss of site surface area
- Designed for Class 1 Hydrocarbons, TSS, TP and TN reduction
- Light, quick and easy to install

Model No.	HYD.40.DC.R6-1
Treatment Flow Rate	40Lps
Connection Size	300mm
Length	7460mm
Diameter	1850mm
Overall height	2670mm
Working Volume	15116Ltrs
Spill Capacity	10087Ltrs

**Note**  
The above data on volumes and sizes is given for the standard model, Risers can be added to bury this system at any depth within any installation requirement, additional costs apply

See PROTECTORS indepth and detailed installation instructions for all SQID devices that are designed and manufactured with a vertical, preassembled, homogenous Fibre-reinforced polymer Tank

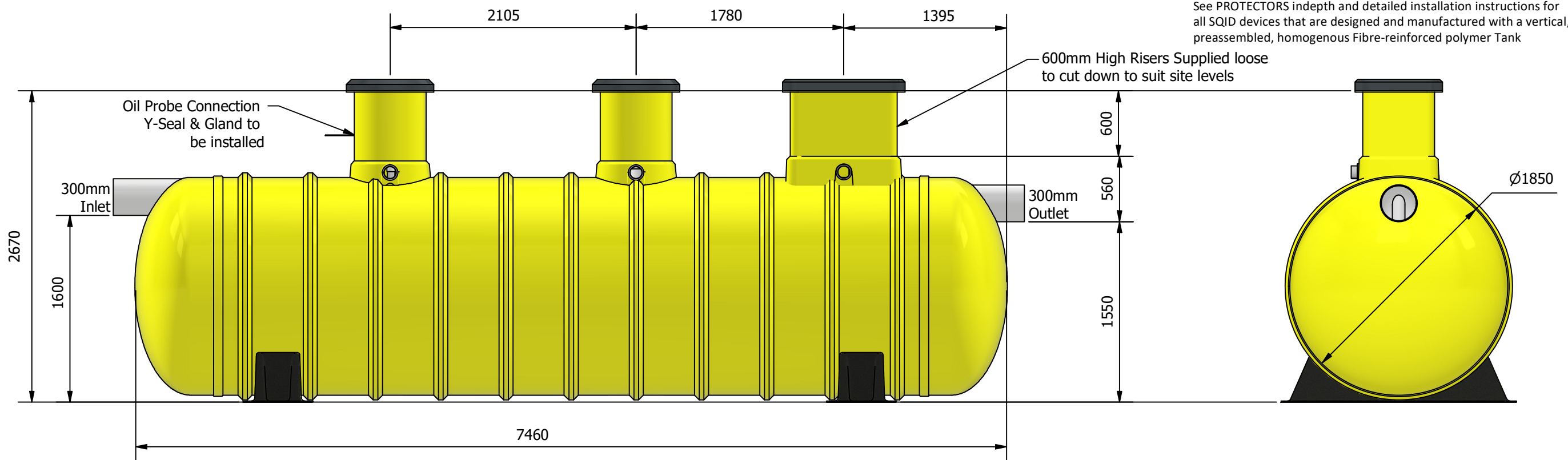
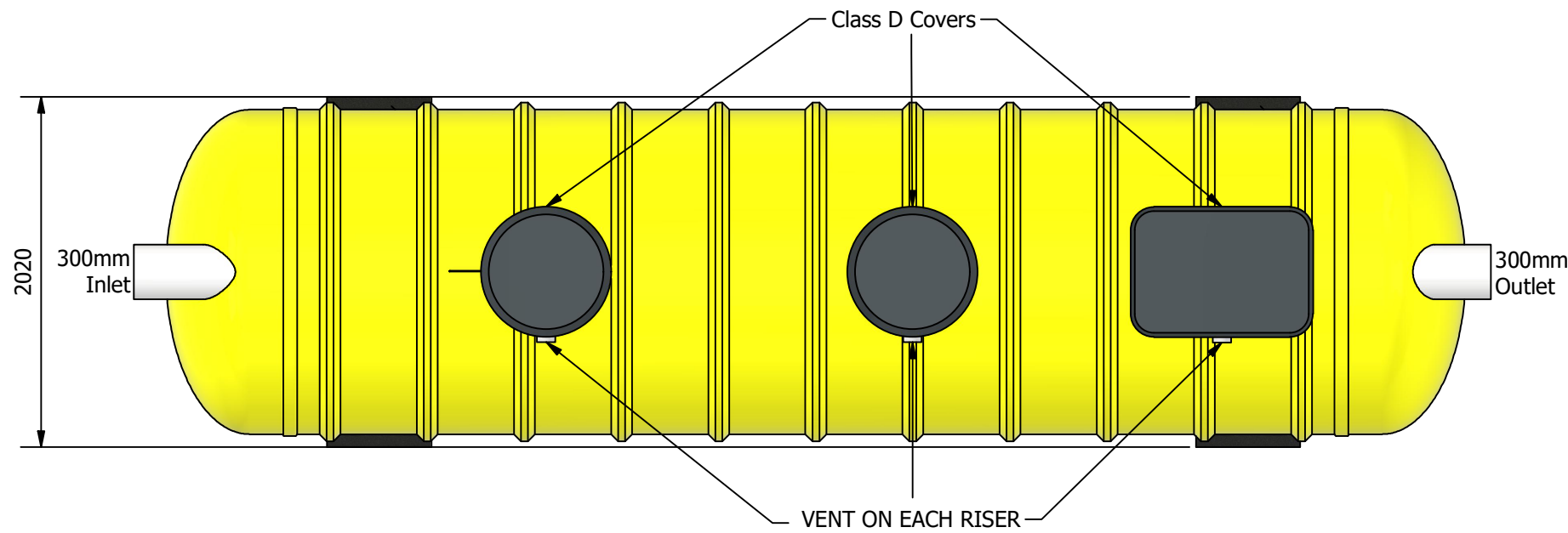

Client:



**APPROVED FOR CONSTRUCTION**

This drawing replaces all previous revisions

Name: \_\_\_\_\_

Client: \_\_\_\_\_

Position: \_\_\_\_\_

Signed: \_\_\_\_\_

Date: \_\_\_\_\_

CONFIDENTIAL - The drawings must not be disclosed to any third parties without written permission from Protector. Unauthorised disclosure may result in prosecution.

This drawing is the property of Protector ABN: 54 642 599 835 and is subject to return on demand. It is submitted for the use only in connection with the proposal and contracts of Protector with the expressed conditions that it is not to be reproduced or copied in any form. This data must only be used in accordance with our standard terms and conditions.

© Copyright

Protector accepts no responsibility for any loss or damage resulting from any person acting on this information. The details and dimensions contained in this document may change, please check with Protector for confirmation of current specifications.

Drawn	Vernon Gatpandan
Client	TBC
Job	TBC
Drawing Type	Cutlist
Job No.	Default Entry

ALL DIMENSIONS ARE IN MILLIMETRES  
UNLESS OTHERWISE STATED

Title:  
HydroProtector - HYD.40.DC.R6-1 -  
DUAL CHAMBER CLASS 1 SEPARATOR  
WITH 10000Ltr Spill Capacity.

Drawing No.  
HYD.40.DC.R6-1 - Rev 3

Sheet No.	Revision
1 / 1	3

