

Technical Data:
 Filter Elements
 Material: Filter substrate Traffic
 Weight: 25 kg

Housing
 Material: Fibreglass

Telescopic extension Tube:
 Material: Polyethylene
 Weight: 5kg

Total Weight: 37kg

The EnviroFilter incorporates Scottish Engineered Filter Media Stormwater Quality Improvement Device and is employed for heavily polluted traffic areas and has been granted general technical approval (Z-84.2-4) by the German Institute for Structural Engineering (DIBt). Because of its up-flow process it can efficiently work in flat sites requiring only 250 mm fall across the device. Multiple units can be manifolded together to treat higher flows.

Each EnviroFilter will provide 8 L/s of treatment flow rate, installed in offline configuration.

- Stormwater treatment filter
- Underground installation, no loss of site surface area
- Designed for TSS,TP and TN removal
- Light, quick and easy to install
- 150-300mm head to drive flow
- Filter modules easy to replace
- 8L/s Treatment Flow rate per Filter

Applications

- Car Parks & Shopping Centers
- Council Depots
- Industrial Estates
- Heavy Vehicle Maintenance
- Transport Depots & Loading Bays
- Tunnels
- Highways & Transport Corridors
- Recycling Yards
- Airport Aprons & Tarmacs

It is available with various filter types, depending on the usage of the connected area.

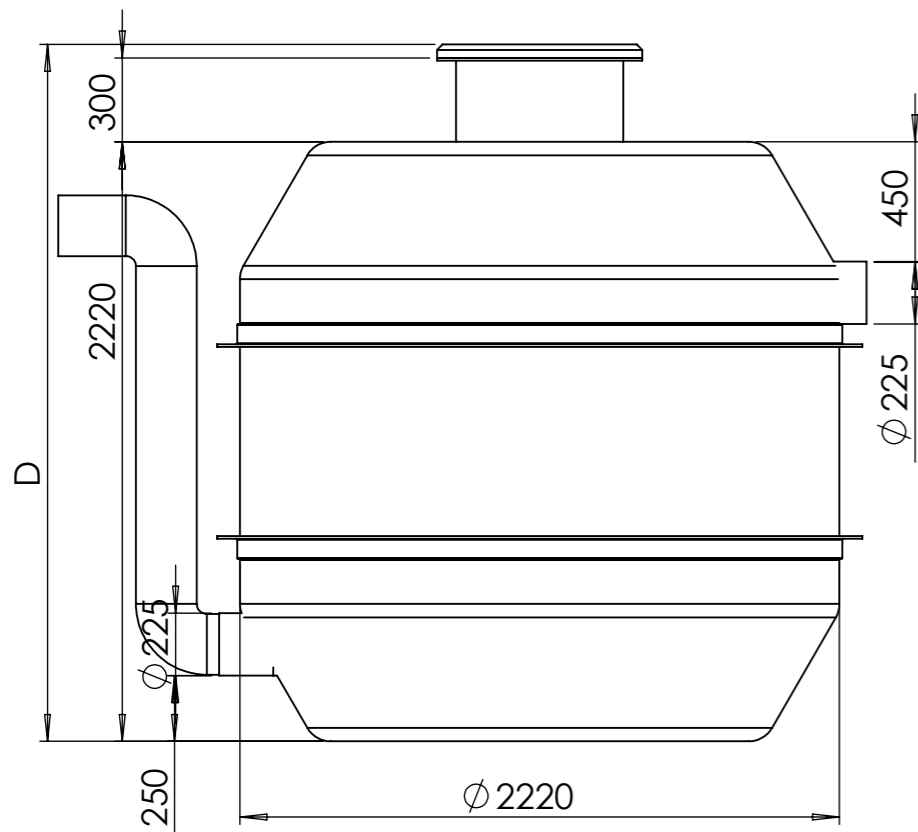

Model	Treatment flow (L/s)	Housing Diameter	Depth (mm)	Connection size (mm)
EPS.2200-9	72	2200	2200	225

MANWAY ACCESS COVERS			
Manway Class	Thickness C (mm)	Material	Total Height D (mm)
Class A	20	FibreGlass	2540
Class B	50	Cast Iron	2570
Class D	100	Cast Iron	2520

Client:

APPROVED FOR CONSTRUCTION
 This drawing replaces all previous revisions

Name: _____
 Client: _____
 Position: _____
 Signed: _____
 Date: _____

CONFIDENTIAL - The drawings must not be disclosed to any third parties without written permission from Protector. Unauthorised disclosure may result in prosecution.
 © Protector - This drawing is the property of Protector ACN: 609512905 and is subject to return on demand. It is submitted for the use only in connection with the proposal and contracts of Protector with the expressed conditions that it is not to be reproduced or copied in any form. This data must only be used in accordance with our standard terms and conditions.
 © Copyright
 Protector accepts no responsibility for any loss or damage resulting from any person acting on this information. The details and dimensions contained in this document may change, please check with Protector for confirmation of current specifications.

Drawn By: _____ Date: _____

Checked By: _____ Date: _____

Approved By: _____ Date: _____

Dig Add



CUSTOMER NAME:		
CUSTOMER REF NO:		
PROJECT NAME:		
PART NO:		
DESCRIPTION:		
REF NO:	SIZE:	SHEET: 1
SCALE: N.T.S	DRAWING NO:	REV:

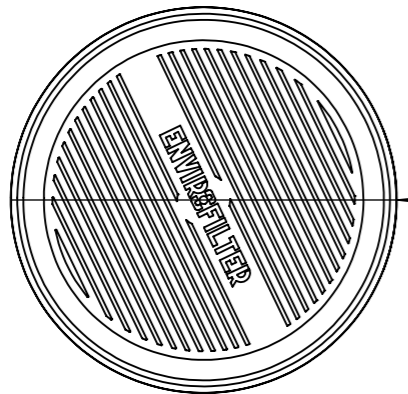

Ø 510

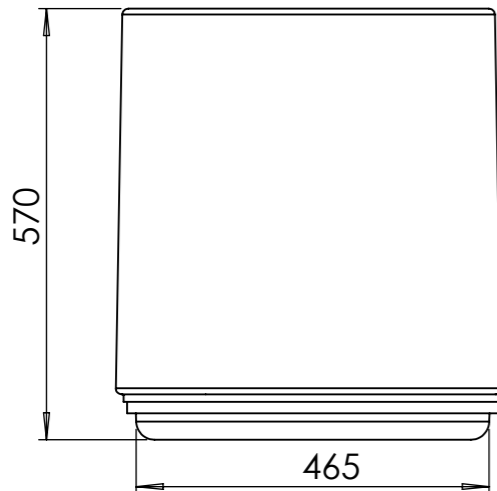

The Protector EnviroProtectoe is a specialist stormwater filter for heavily polluted traffic areas, designed for installation within new or existing chambers. The system operates in an up-flow process resyltiung in minimal head drop between the inlet and outlet. The stormwater is treated withing the unit by the following processes:

- Sedimentation
- Filtration
- Adsorption
- Precipitation

The specially made Enviro filter consists of oil coeessing, pre filtratoin, glass 30 micron filtrationand a zeolite adsorbtion matruails to ensure maximum stormwater treatment.

Rainwater is collected in the basal section of the filter housing and the angled inlet generates a radial flow pattern. The hydrodynamic separator concertsturbulent waters into the raidal laminar flow pattern generating particle sedimentation. This sedimentation is retained in the silt trap below the separator, which is designed for a simple and ease of cleaning.

The filter elements filter out the fine materials in an upflowprocess and dissolved materials are precipitated and adsorbed. The filter is then backwashed from above. When exhausted the maintenance and replacement of the filter is simply removed from the shaft housing.

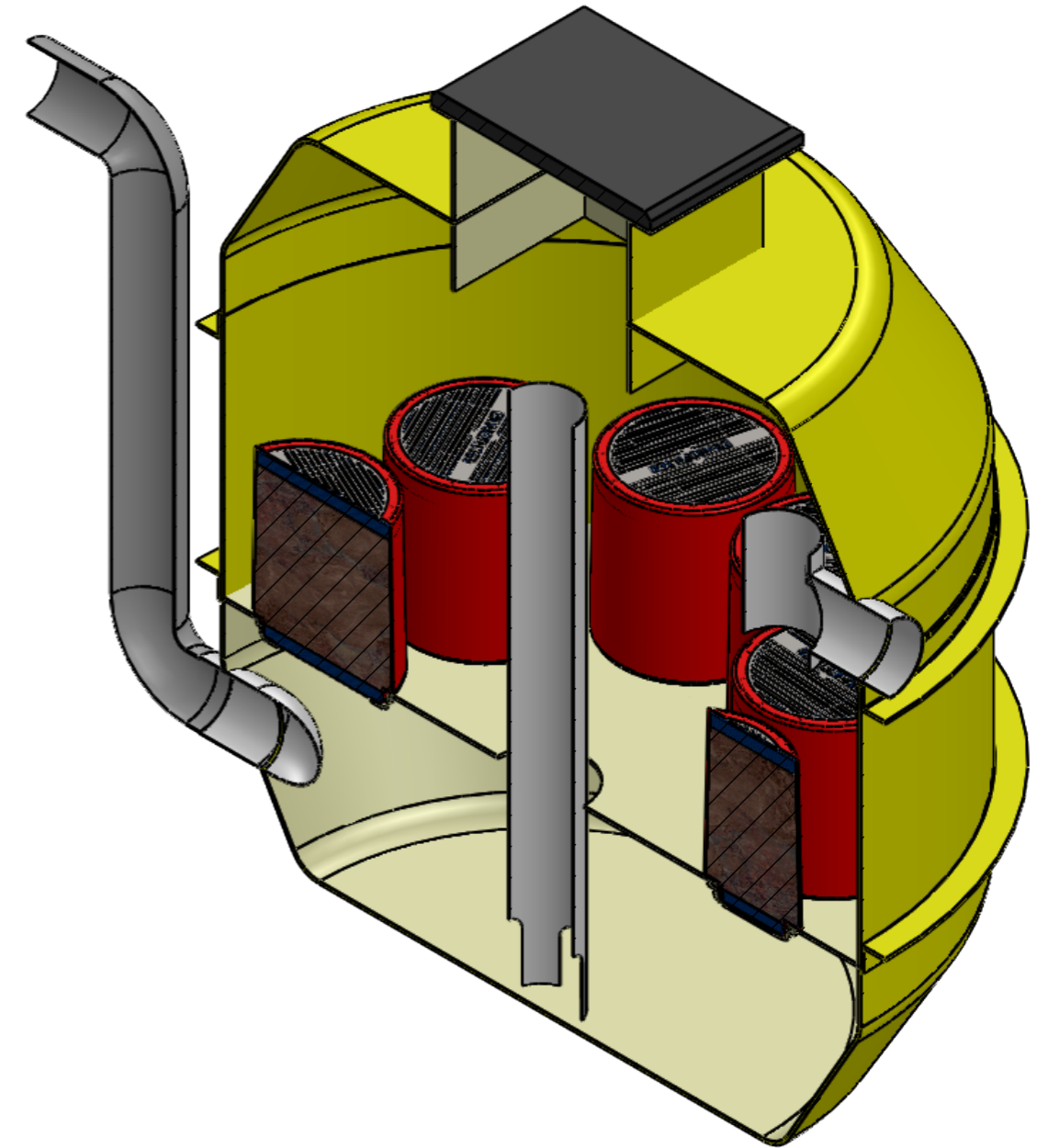
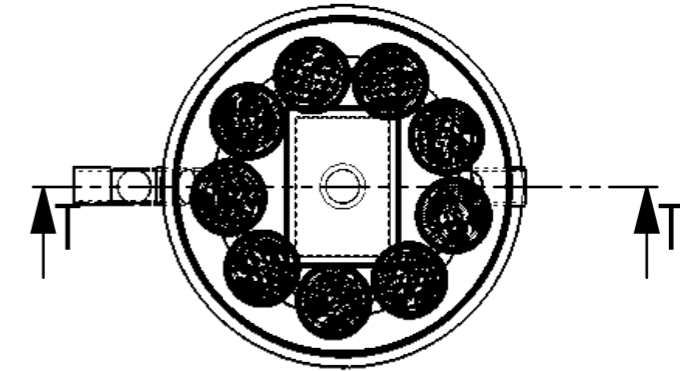

Client:

APPROVED FOR CONSTRUCTION
This drawing replaces all previous revisions

Name: _____

Client: _____

Position: _____

Signed: _____

Date: _____

CONFIDENTIAL - The drawings must not be disclosed to any third parties without written permission from Protector. Unauthorised disclosure may result in prosecution.
© Protector - This drawing is the property of Protector ACN: 609512905 and is subject to return on demand. It is submitted for the use only in connection with the proposal and contracts of Protector with the expressed conditions that it is not to be reproduced or copied in any form. This data must only be used in accordance with our standard terms and conditions.
© Copyright
Protector accepts no responsibility for any loss or damage resulting from any person acting on this information. The details and dimensions contained in this document may change, please check with Protector for confirmation of current specifications.

Drawn By:
AP

Date:
17/5/17

Checked By:

Date:

Approved By:

Date:

Dig Add



CUSTOMER NAME:

CUSTOMER REF NO:

PROJECT NAME: Protector by ProtecFRP

PART NO: EcoProtector 2500 Vessel

DESCRIPTION: HYDRODYNAMIC, FULL CAPTURE, HIGH CAPACITY TRASH AND DEBRIS REMOVAL GROSS POLLUTANT TRAP

REF NO:

SIZE:

SHEET: 1

SCALE: N.T.S

DRAWING NO: 17-2017

REV:

Installation

The guide provides advice for lifting, OHS measures, handling techniques and other important requirements. Installation is typically:

1. Excavate hole
2. Place station in hole
3. Fill well with water about 20% of total volume
4. Back fill to locking ring
5. Pour ballast
6. Install all connections as per manual*
7. Back fill and pour top slab and install access cover

*All installation requirements are as per installation data manual.

Applications

- Car Parks & Shopping Centers
- Council Depots
- Industrial Estates
- Heavy Vehicle Maintenance
- Transport Depots & Loading Bays
- Tunnels
- Highways & Transport Corridors
- Recycling Yards
- Airport Aprons & Tarmacs

It is available with various filter types, depending on the usage of the connected area.

Concrete Apron If Required

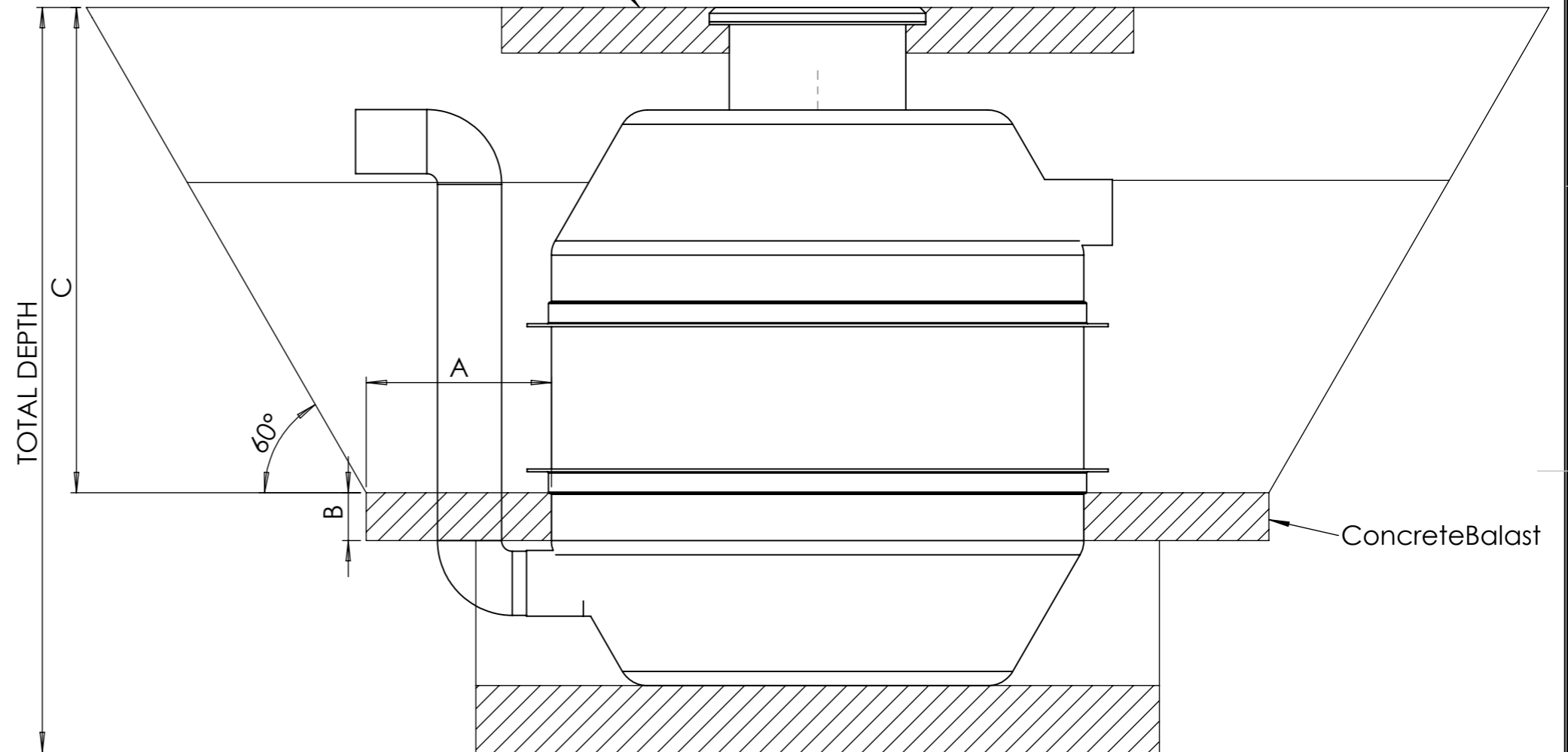

Dimension	(mm)
A	730
B	450
C	1800
TOTAL DEPTH	2700
Volume of Concrete Balast (m ³)	3.05

Client:

APPROVED FOR CONSTRUCTION
This drawing replaces all previous revisions

Name: _____

Client: _____

Position: _____

Signed: _____

Date: _____

CONFIDENTIAL - The drawings must not be disclosed to any third parties without written permission from Protector. Unauthorised disclosure may result in prosecution.
© Protector - This drawing is the property of Protector ACN: 609512905 and is subject to return on demand. It is submitted for the use only in connection with the proposal and contracts of Protector with the expressed conditions that it is not to be reproduced or copied in any form. This data must only be used in accordance with our standard terms and conditions.
© Copyright
Protector accepts no responsibility for any loss or damage resulting from any person acting on this information. The details and dimensions contained in this document may change, please check with Protector for confirmation of current specifications.

Drawn By:

Date:

Checked By:

Date:

Approved By:

Date:

Dig Add



CUSTOMER NAME:

CUSTOMER REF NO:

PROJECT NAME:

PART NO:

DESCRIPTION:

HYDRODYNAMIC, FULL CAPTURE, HIGH CAPACITY TRASH AND DEBRIS REMOVAL GROSS POLLUTANT TRAP

REF NO:

SIZE:

SHEET: 1

SCALE: N.T.S

DRAWING NO:

REV: